

## Flat Panels for Ceilings

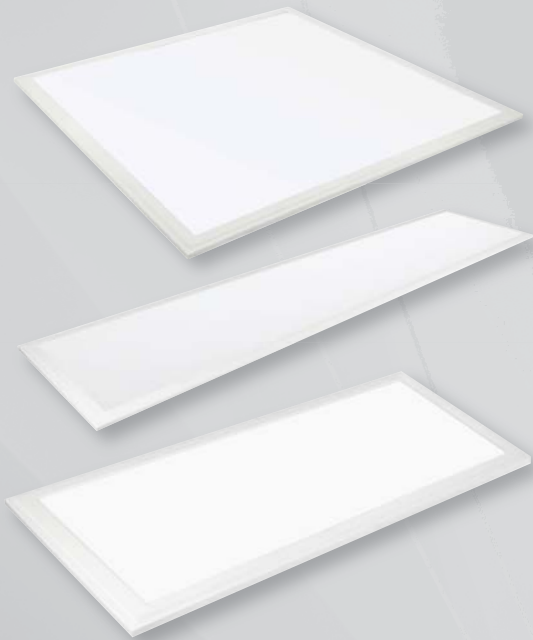





### Features

- Ultra slim polystyrene diffuser
- Extruded aluminium frame
- Slide switch function for colour temperature change
- High efficiency SMD chips
- Constant current driver
- 0.6m flex & plug
- Operating temp: -20°C to +45°C
- IP40 rated

### Installation Options

- Recessed plaster ceiling installation (plaster frame is required)
- Surface mounted installation (surface mounted frame is required)
- Suspended (suspension kit is required)

**IPART  
VEET  
APPROVED**

<b>CERTIFICATION</b>	<b>IP RATING</b>	<b>DIMMABLE</b>
		
<b>COLOUR CHANGE</b>	<b>DOUBLE INSULATED</b>	<b>BOX   CTN QTY</b>
		<b>1   5</b>

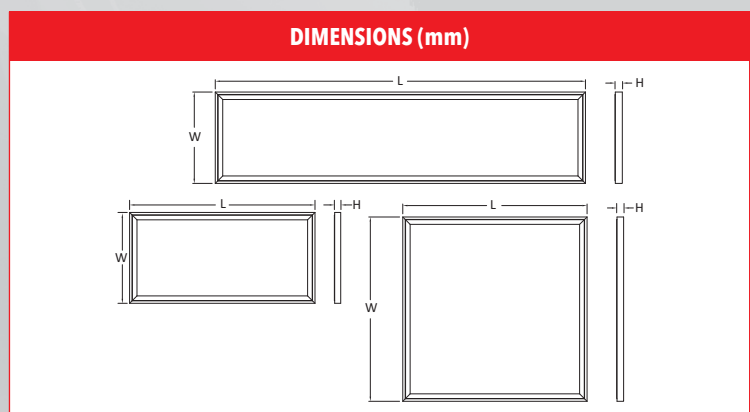

Part No.	Voltage	Watt	PF	CCT	Ra	Lumens	Beam Angle	Lifetime hrs	Fitting Colour	Dimensions (L x W x H)mm
TSFP3060TRI	200-240V	25W	0.9	3000K-4000K-5700K	80	1977-2278-2280	120°	40,000	White	595 x 295 x 8
TSFP6060TRI	200-240V	36W	0.9	3000K-4000K-5700K	80	3072-3627-3707	120°	40,000	White	595 x 595 x 8
TSFP30120TRI	200-240V	36W	0.9	3000K-4000K-5700K	80	3072-3627-3707	120°	40,000	White	1195 x 295 x 8